

MACHINEX

- AFTER SALE SUPPORT 24/7
- REMOTE ASSISTANCE
- MANUAL CHAGE OVER TOOL FREE
- CHANGE OVER TIME UP TO 20 MINUTES FOR ONE TRAINED OPERATOR

WRAP AROUND CASE PACKER

ATOMAX

REMOTE ASSISTANCE

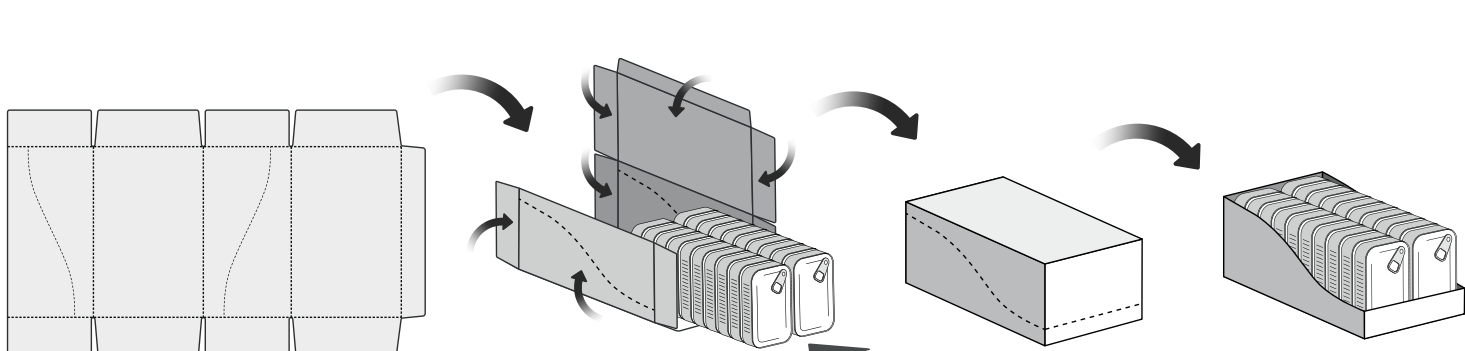
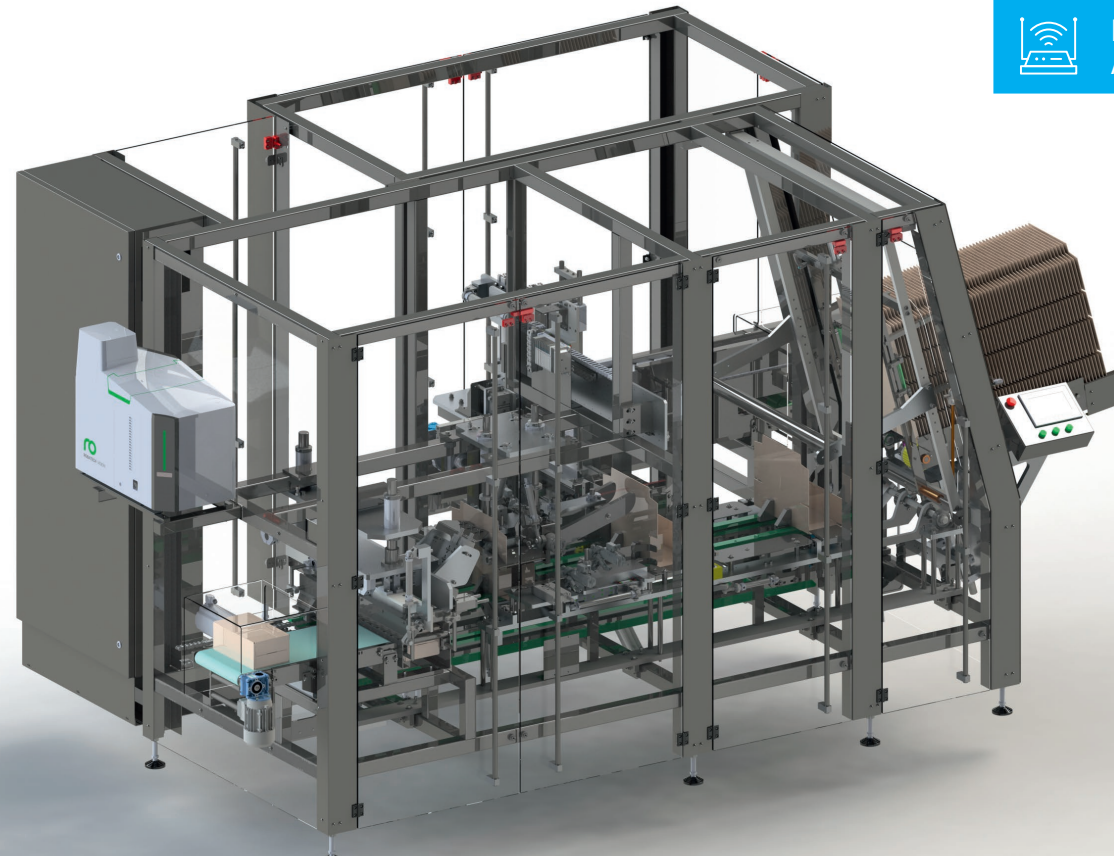

ATOMAX is presented as a family of wrap around case packers: full wrap around, open tray wraps around solution or double case loading solution – all designed and produced for different applications in industries.

Machinex wrap around case packers, ATOMAX, are designed for demanding working regime in dairy, meat, chemical and other production facilities in 24/7 working hours.

ATOMAX WRAP AROUND SYSTEM is created as automatic case packer: to form the case, prepare products for loading, folding and sealing case's flaps around group of loaded products. Operates automatically based on electronic controls and installed programs. Hi-speed solutions are driven by servo motors to achieve maximum capacities.

Case type: flat preformed cardboard blank.

Case sealing: hot melt.

ATOMAX is indexing motion case packer. Manually adjustable for different case's dimensions in 20 minutes, tool free.

Automatic change over upon request.

ATOMAX

ATOMAX WRAP AROUND OPEN TRAY SOLUTION

REMOTE ASSISTANCE

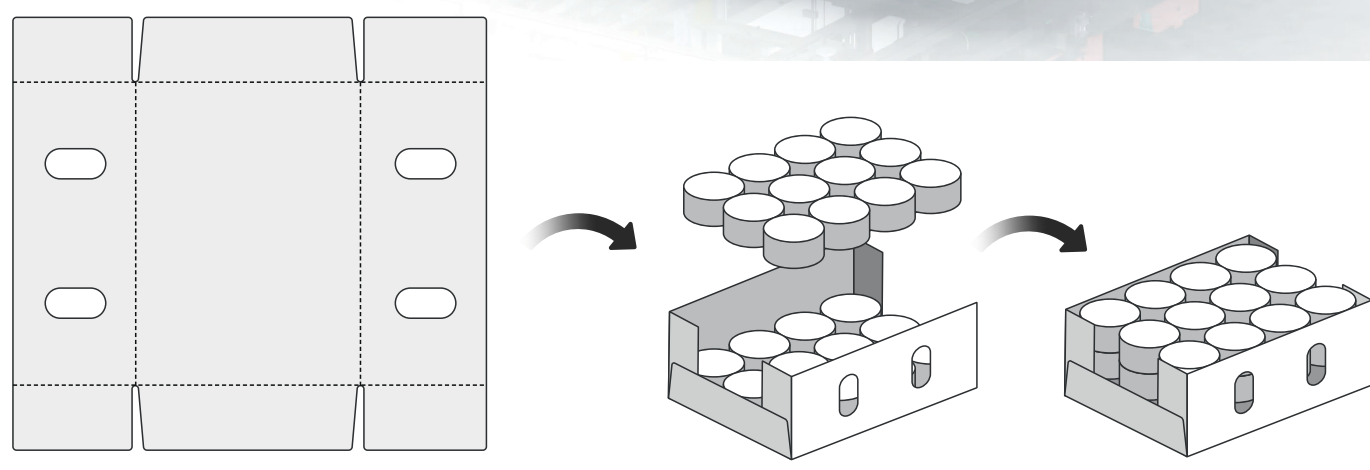
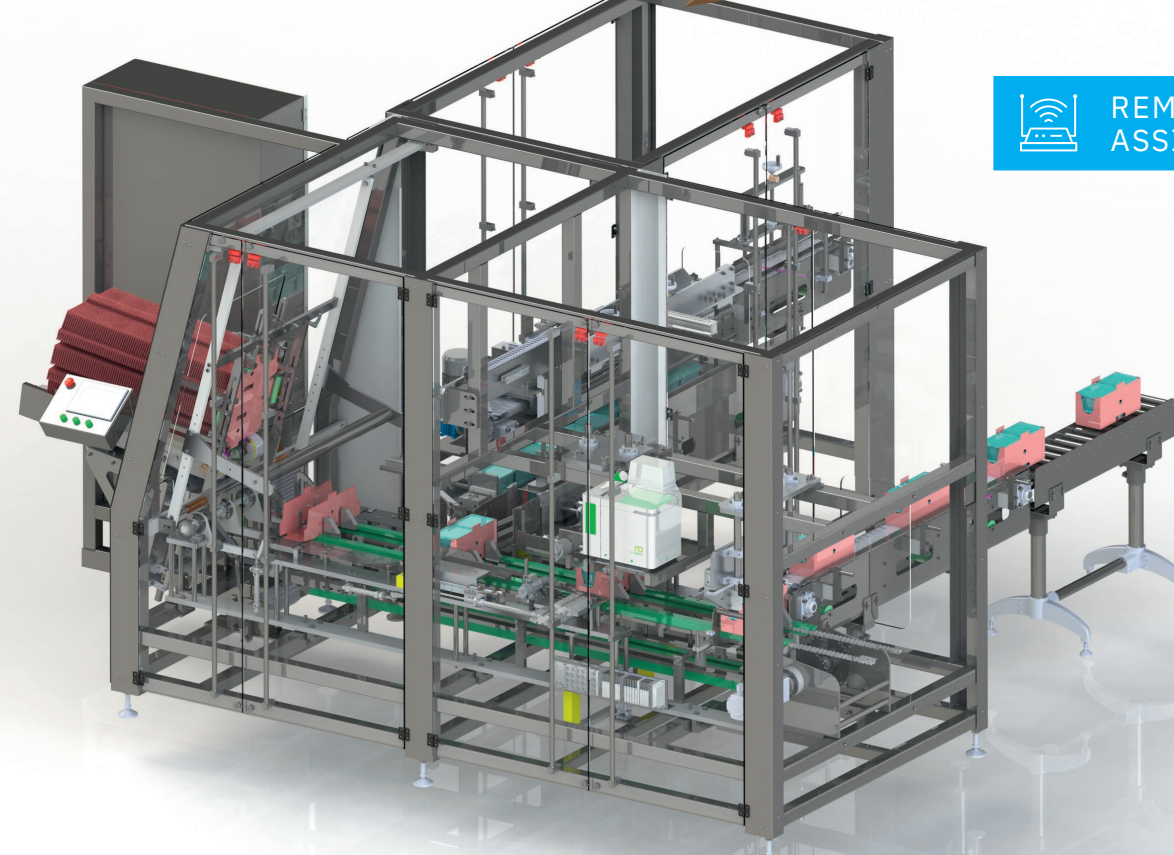

ATOMAX OPEN TRAY is designed as wrap around case packer for some self-supporting products, which can be palletized without cover part of the case.

ATOMAX wrap around system is created as automatic case packer: to form the case, prepare products for loading, folding and sealing case's flaps around group of loaded products. Operates automatically based on electronic controls and installed programs. Hi-speed solutions are driven by servo motors to achieve maximum capacities.

This is a fully automated wrap around case packer providing packaging in open tray type case. It is possible to have on one machine two types of cases: open tray and fully closed box. Machinex wrap around case packers, ATOMAX, are designed for demanding working regime in dairy, meat, chemical and other production facilities in 24/7 working hours.

Case type: flat preformed cardboard blank.

Case sealing: hot melt.

ATOMAX is indexing motion case packer. Manually adjustable for different case's dimensions in 20 minutes, tool free.

Automatic change over upon request.

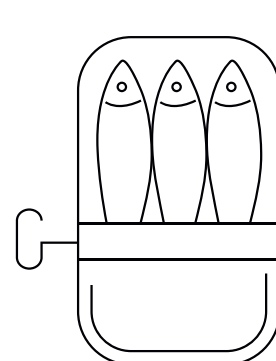
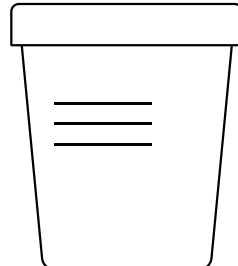
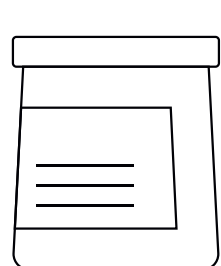
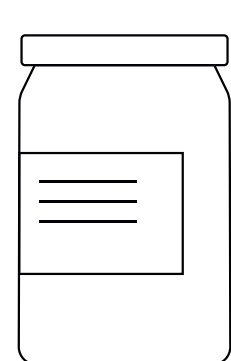

MACHINEX

Slovenski put 6A, 35000 Jagodina – Serbia

Mobile: +381 63 641 511 • Office: +381 35 241 600 • Fax: +381 35 241 600
Email: info@machinex.rs • Website: https://machinex.rs/